

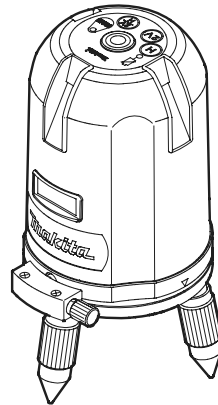

# Laser Level

Model SK20SP



**⚠WARNING:**

For your personal safety, READ and UNDERSTAND before using.  
SAVE THESE INSTRUCTIONS FOR FUTURE REFERENCE.

## ENGLISH

# SPECIFICATIONS

The laser-beam lines can be rotated horizontally at any angle of 360° by turning the head of the unit. Mounting thread for connecting to tripod is provided.

Model	SK20SP
Laser-beam line	Laser Type : Red Laser 635nm < 1mw (Laser Class 2) Line-width : 2.5 mm / 10 m Emitting angle of the laser-beam line : Vertical: 140°± 10% Horizontal: >100° Diameter of Plumb laser: 1.5 mm
Operating mode	3 modes Horizontal Vertical + Right angle (Vertical)+Plumb Point (floor) Right angle (Vertical) + Horizontal
Operating mode	2 modes Interior / Exterior
Leveling Range	±2.0° (plumb leveling) The laser-beam lines will be shut off automatically without the leveling range.
Leveling Accuracy	±1mm / 10 m
Power Supply	AA alkaline dry battery, 1.5V : 2 pieces
Operating Time	Horizontal : Approx. 20 hrs. Vertical : Approx. 9 hrs. Vertical + Horizontal : Approx. 7 hrs.
Battery Warning Signal	Battery life indicator LED (yellow) lights on when the batteries become weak. At the end of battery life the laser-beam lines will be shut off.
Dimensions	Diameter ø75mm x Height 159 mm
Weight	830 g (batteries not included)
Tripod Mounting Thread	W 5/8 "
Standard Equipment	Alkaline dry battery : 2 pieces Carrying Case Makita SK20 exclusive uses Elevating Tripod

- Due to our continuing program of research and development, the specifications herein are subject to changes without notice.
- The operating time varies depending on the operating environment

## Symbols

The followings show the symbols used for the laser level. Be sure that you understand their meaning before use.



- Read instruction manual.



- Laser class 2



- Do not stare into laser.

## Intended Use

The laser level is developed and designed for establishing and measuring the accurate level, plumb, square reference and plumbs points.

## SAFETY INSTRUCTIONS

**WARNINGS:** When using the laser level, basic safety precautions should be followed to reduce the risk of personal injury.

Read all these instructions before attempting to operate the laser level and save these instructions.

### For safe operation:

Laser radiation of laser class 2

1. Do not stare into laser.
2. Do not direct the laser beam at persons.
3. Do not remove the warning labels from the unit.
4. Do not modify the laser level in any way. Service or maintenance must be performed only by qualified personnel.
5. Do not allow children to operate the laser level.
6. Do not operate the laser level around children.
7. Do not look at the beam directly with optical

apparatus.

### Use and care for laser level

To use the laser level properly and keep your work accurate:

The laser level must be set where it is not exposed to rain.

Do not expose the laser level to extreme temperatures and temperature variations.

The laser level is a very precise measuring instrument.

Handle the laser level very carefully not to drop it or give strong impacts to the outside of the tool-body.

Always check the accuracy of laser before use.

For a better visibility of the laser-beam line, Receiver is available as an optional accessory. Use the receiver when it is difficult to see the laser-beam line.

Battery life indicator LED (yellow) indicates that the batteries become weak.

Replace all the batteries (2 pieces) at one time with new alkaline ones.

When you finish your work, always be sure that the laser level is switched off and the laser-beam lines is not projected.

Always keep the laser level in the carrying case when it is carried.

### Explanation of general view

- |   |   |   |
|---|---|---|
| 1. Operating-mode selecting buttons<br>(H, 2V,2V/H) | 5. Battery life indicator LED (yellow)    | 10. Tripod connection                   |
| 2. Interior/exterior mode change button             | 6. Exit opening for vertical laser beam   | 11. Exit opening for plumb laser beam   |
| 3. Exterior mode indicator LED (green)              | 7. Exit opening for horizontal laser beam | 12. Power switch (Switch lock provided) |
| 4. Round vial with backlight                        | 8. Fine rotation-adjusting knob           | 13. Battery cover                       |
|   | 9. Level adjusting ring                   | 14. Tool-strap                          |

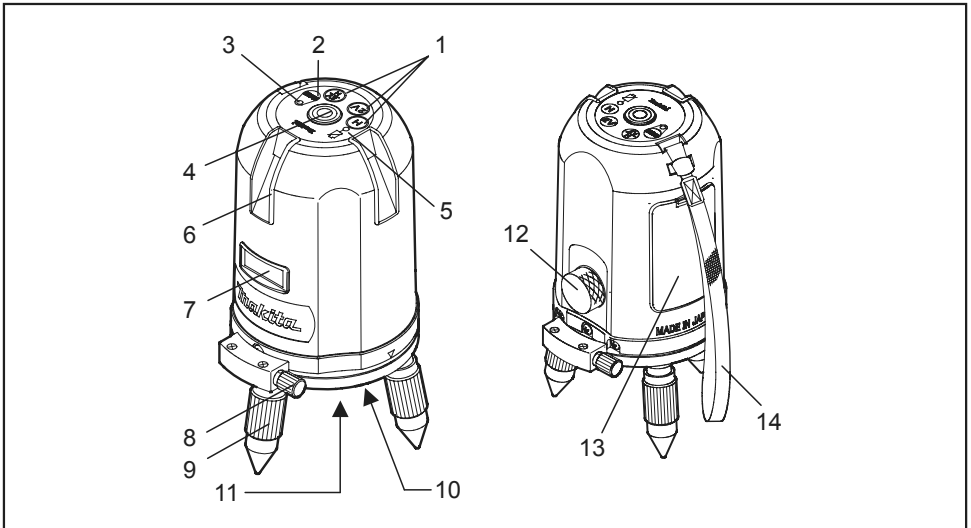

## Attaching and replacing batteries (Fig.1)

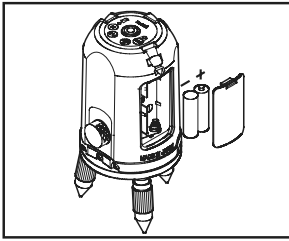

Fig. 1

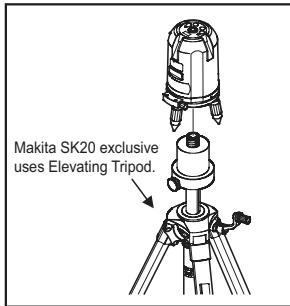

Fig. 2

## OPERATION

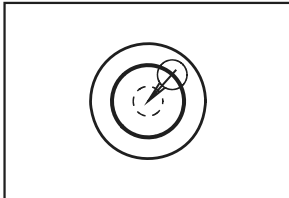

Fig. 3

1. Turn on the power switch (12). The unit (laser level) projects the horizontal laser- beam line.
2. If the unit is placed in a slanting position, it will not emit any laser lines at all. Adjust the level adjusting ring (9) so that the air-bubble in the round vial (4) is centered. (See the Fig. 3)
3. If you work with the receiver (optional accessory), press the interior/exterior mode change button (2). Exterior mode indicator LED (green) (3) will light on.

Following 3 operation modes are available. Press the most suitable operating-mode selecting button (1) according to your job.

## Horizontal

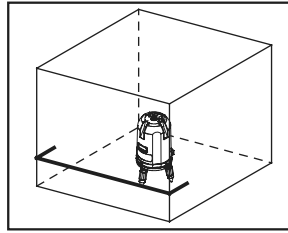

Fig. 4

Press the H button. The unit projects the horizontal laser-beam line as illustrated in Fig.4.

You can adjust the height of the horizontal laser line by mounting the unit to Elevating tripod provided (See the Fig. 2)

## Vertical + Right angle (Vertical) + Plumb Point (floor)

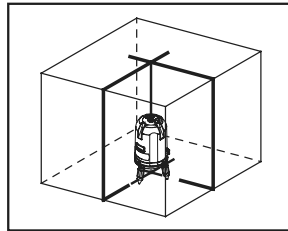

Fig. 5

Press the 2V button. The unit projects the vertical laser-beam lines as illustrated in Fig.5.

## Vertical + Right angle (Vertical) + Horizontal + Plumb Point (floor)

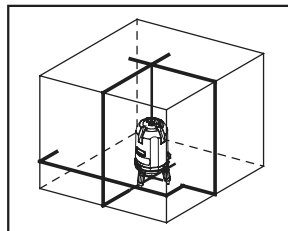

Fig. 6

Press the 2V/H button. The unit projects the laser-beam lines (2 vertical and horizontal ones) as illustrated in Fig.6.

4. Turn off the power switch after operation. The unit will be automatically locked.

## Inspection of the leveling accuracy of the laser level

Check the leveling accuracy of the unit (laser level) periodically in the following manners:

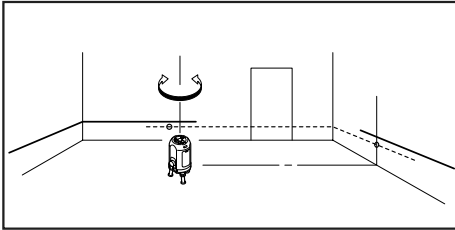

Fig. 7

1. Check the leveling accuracy of horizontal laser-beam line.
  - 1) Place the unit on the floor of an indoor corner at the point of 3 to 5 m from the one wall and 1 m from the another one. (See the Fig.7) Turn the level adjusting ring (9 ) so that the air-bubble in the round vial (4) is centered.
  - 2) Turn on the power switch (12).
  - 3) Turn the unit and mark both ends of laser line projected on the both walls.
  - 4) Then turn the unit on both sides. Make sure that half of the deviation from laser line to the first marked point is within the leveling accuracy specified.
2. Check the leveling accuracy of vertical laser-beam line.

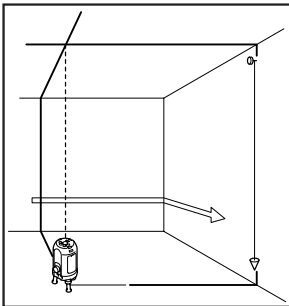

Fig. 8

- 1) Hang a plumb-bob (See the figure 8) from 3 m height of the wall (the height of ceiling is approx. 3 m). Place the unit on the floor at the point of 2 to 5 m away from the wall. Make sure that the air-bubble is centered in the round vial (4).

- 2) Turn on the power switch 12. Then press the V button.
- 3) Direct the vertical laser line to the string of plumb-bob. Then adjust the vertical laser line to the lower end of the string. Make sure that deviation from the vertical laser line to the upper end of the string is within the leveling accuracy specified.

---

---

---

---

---

---

---

---

---

---

---

---

---

---

---

---

---

---

---

---

---

---

---

---

---

---

---

---

---

---

---

---

---

---

---

---

---

---

---

---

---

---

---

---

---

---

---

---

---

---

---

Makita Corporation